



PRICE PUMP®

CENTRIFUGAL PUMPS



THINK QUALITY
THINK DELIVERY
THINK PRICE

TABLE OF CONTENTS

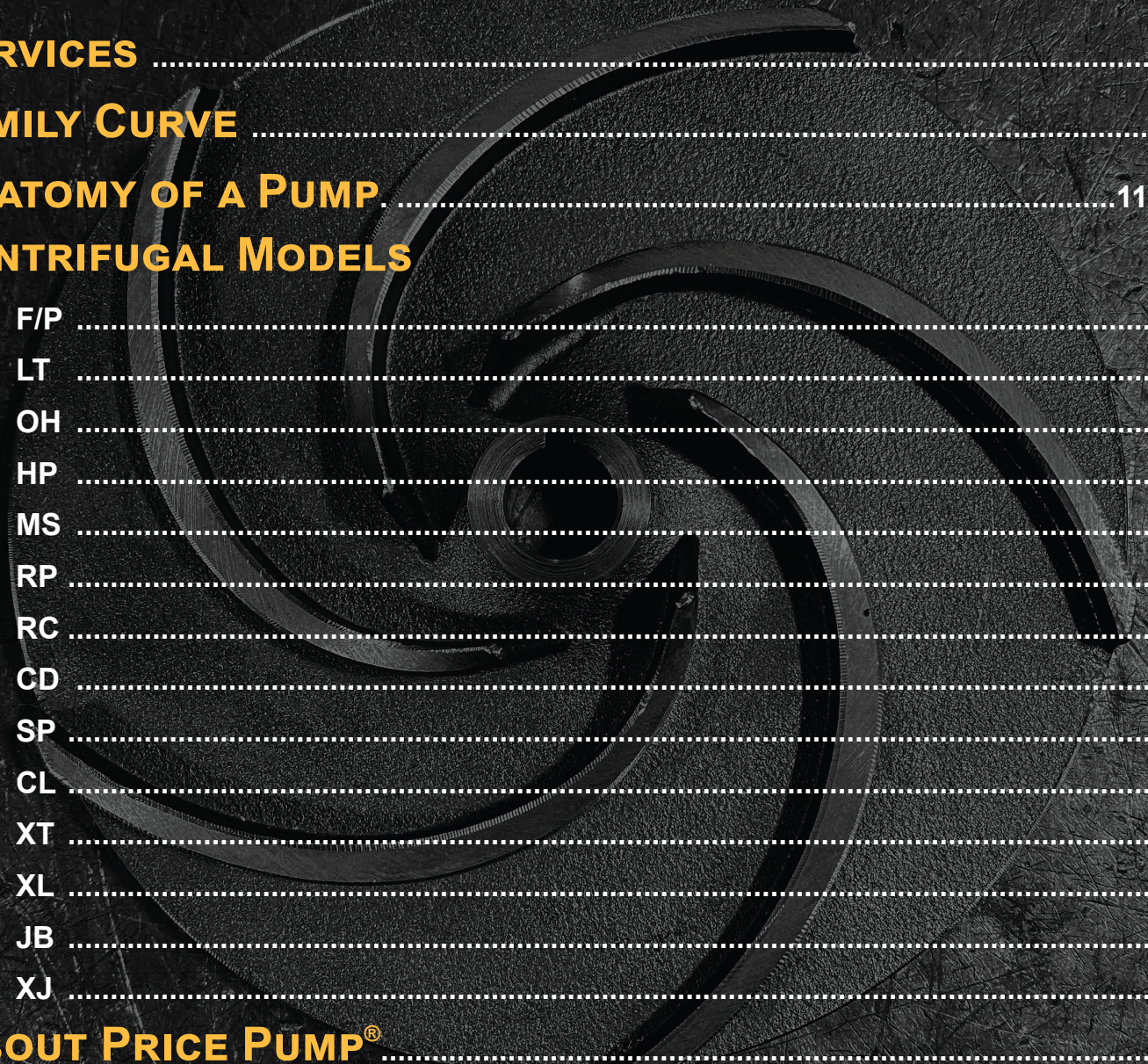

APPLICATIONS AND FEATURES	2
SERVICES	3
FAMILY CURVE	4
ANATOMY OF A PUMP	11-12
CENTRIFUGAL MODELS	
F/P	5
LT	6
OH	7
HP	8
MS	9
RP	10
RC	13
CD	14
SP	15
CL	16
XT	17
XL	18
JB	19
XJ	20
ABOUT PRICE PUMP®	21

APPLICATIONS AND FEATURES

ADVANTAGES

BROAD RANGE OF SIZES & CONFIGURATIONS – 14 DIFFERENT PUMP FAMILIES WITH OVER 125 UNIQUE MODELS

MATERIALS OF CONSTRUCTION – 316SS, CAST IRON, BRONZE, HASTELLOY AND MULTIPLE NON-METALLIC MATERIALS ARE AVAILABLE

MECHANICAL SEALS – A WIDE VARIETY OF STANDARD MECHANICAL SEALS ALONG WITH CUSTOM SEAL DESIGNS ARE AVAILABLE

LOW MAINTENANCE – RELIABLE PUMP OPERATION REDUCES DOWN TIME AND KEEPS MAINTENANCE COSTS AT A MINIMUM

APPLICATIONS

CHILLERS / LIQUID COOLING • SEMI-CONDUCTOR • CHEMICAL HANDLING / TRANSFER • WATER TREATMENT • DEIONIZED WATER
PHARMACEUTICAL • CAUSTIC FLUIDS • SCRUBBER APPLICATIONS • FRAC WATER TREATMENT • VAPOR DEGREASERS
WASTEWATER TREATMENT • PULP AND PAPER • INDUSTRIAL / CHEMICAL PROCESSING • FILTRATION • BIODIESEL PRODUCTION

DESIGN FEATURES

COMPACT DESIGN – A COMPACT, CLOSE COUPLED DESIGN ALLOWS FOR EFFICIENT PLACEMENT IN A VARIETY OF APPLICATIONS AND INSTALLATIONS.

MECHANICAL SEALS – ALL COMMONLY AVAILABLE MECHANICAL SEALS ARE UTILIZED FOR EASE OF AVAILABILITY. SPECIALTY MATERIALS ALSO AVAILABLE AND COMMONLY STOCKED FOR QUICK DELIVERY.

AVAILABLE OPTIONS – RECIRCULATION LOOPS, SEAL FLUSH, SAMPLING PORTS, AIR/VAPOR PURGE AND INSTRUMENTATION PORTS ARE AVAILABLE OFF THE SHELF. FRAME MOUNT & BASE PLATE MOUNTING. SHAFTS ARE AVAILABLE WITH A TUNGSTEN CARBIDE COATING FOR ABRASIVE APPLICATIONS. MAGNETICALLY DRIVEN AND VERTICAL OPTIONS ARE AVAILABLE AS WELL.

UNIVERSAL BRACKETS PUMP BRACKETS MOUNT TO A VARIETY OF STANDARD NEMA MOTORS RANGING FROM NEMA 42C, NEMA 56C AND 56J, AND 143 - 365JM MOTORS.

PERFORMANCE

FOURTEEN DIFFERENT PUMP MODELS ARE AVAILABLE TO MEET A WIDE RANGE OF PERFORMANCE REQUIREMENTS

- CAPACITIES TO 1100 GPM
- HEADS TO 380 FEET
- TEMPERATURE FROM CRYOGENIC TO 350F
- WORKING PRESSURES TO 300 PSIG
- CLOSE COUPLED MOTORS TO 100 HP



SERVICES



STANDARD PRODUCT SERVICES

PUMP LEAD TIME – 7 TO 10 WORKING DAYS
TWO YEAR PRODUCT WARRANTY
NEXT-DAY SHIPMENT ON ALL SPARE PARTS
WORLDWIDE AUTHORIZED SERVICE CENTERS
“PUMP SELECTION INSTRUCTOR” (PSI) PUMP SELECTION PROGRAM
WORLDWIDE PRODUCT DISTRIBUTION, SERVICE AND SUPPORT



VIP EXPEDITED SERVICES

SAME DAY EXPEDITED SHIPPING FOR PUMPS AND PARTS
PARTS ORDER NEEDED YESTERDAY (PONY) SHIPPING AVAILABLE
NEXT-DAY EXPEDITED SHIPPING FOR PUMPS
MULTIPLE STANDARD CONFIGURATIONS AVAILABLE FOR MOST PRODUCTS
ALL PUMPS CAN BE CUSTOM SPECIFIED/MODIFIED



APPLICATION SUPPORT SERVICES

APPLICATION SPECIALISTS AVAILABLE TO DISCUSS YOUR APPLICATIONS
APPLICATIONS SUPPORT RESPONSE WITHIN 24 HOURS
TEST AND EVALUATION PRODUCT AVAILABLE
VFD PROGRAMMING, TROUBLESHOOTING AND TECHNICAL SUPPORT



ENGINEERING / OEM SUPPORT SERVICES

CUSTOM OR APPLICATION SPECIFIC DESIGN SERVICES
PERFORMANCE / LIFE TESTING AND PRODUCT DEVELOPMENT SERVICES
COMPLIANCE TESTING SERVICES
OEM SPECIFIC MODIFICATIONS / SYSTEM INTEGRATION

FAMILY CURVE

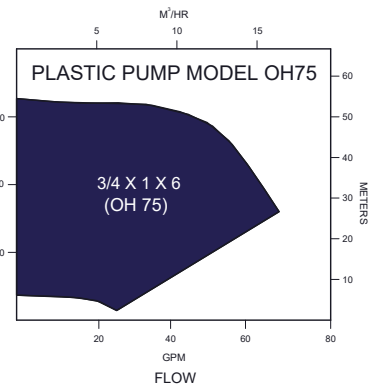
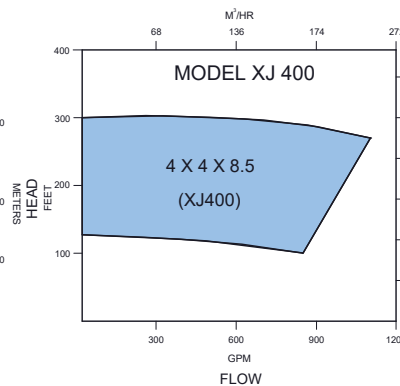
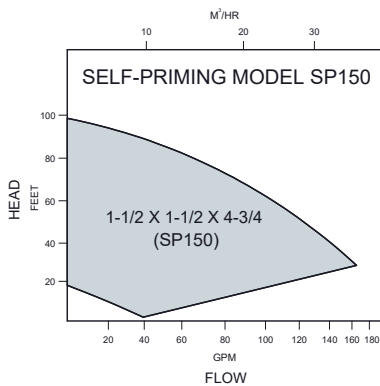
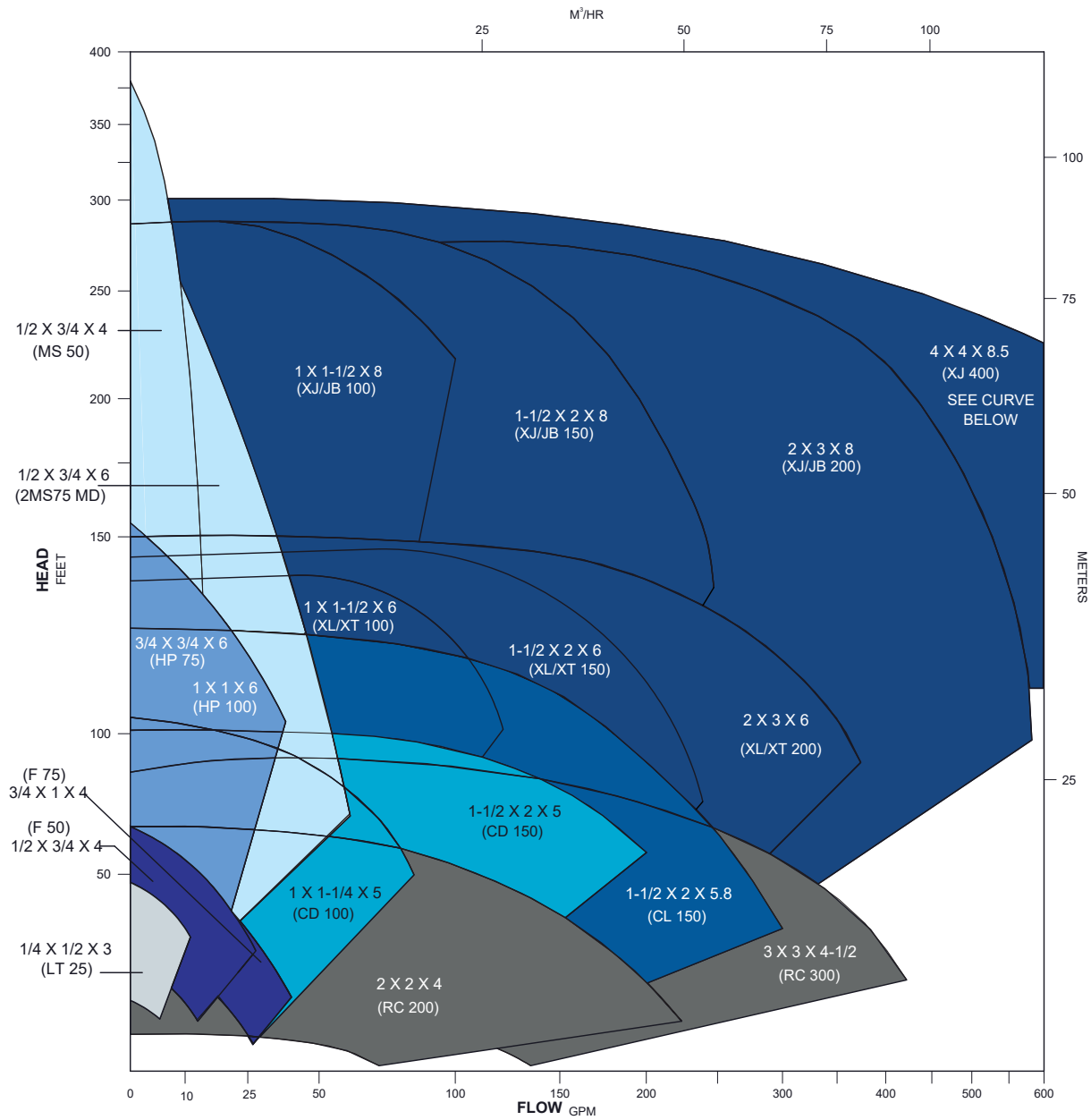

TYPE F/P

FLOWS TO 45 GPM / HEADS TO 65 FEET



MATERIALS

- IRON
- BRONZE

MODELS

- F50 – .5" x .75" x 3.94"
- F75 – .75" x 1" x 3.75"
- P50 – .5" x .75" x 3.94"
- P75 – .75" x 1" x 3.75"

APPLICATIONS

- AIR CONDITIONING
- WASHER MACHINES
- CARPET CLEANERS
- BILGE PUMPS
- WASH DOWN
- CIRCULATING PUMPS
- COOLANT PUMPS
- BRINE CIRCULATION

FEATURES

- NEMA 56J MOTOR FRAME
- STANDARD MECHANICAL SEAL: 5/8" TYPE 6A BUNA, CARBON VS. CERAMIC
- MULTIPLE SEAL OPTIONS AVAILABLE
- COMPACT CLOSE COUPLED DESIGN
- FRAME MOUNT & BASE PLATE OPTION AVAILABLE

TYPE LT

FLOWS TO 12 GPM / HEADS TO 48 FEET



MATERIALS

- STAINLESS STEEL
- BRONZE

MODELS

- LT25- .25" x .5" x 3.34"

APPLICATIONS

- VAPOR DEGREASERS
- CHILLERS
- FILTER SYSTEMS
- WATER TRANSFER
- SOLVENTS
- WATER TREATMENT SYSTEMS
- INDUSTRIAL CHEMICALS
- ALKALINE SOLUTIONS
- DEIONIZED WATER

FEATURES

- NEMA 42C MOTOR FRAME
- STANDARD MECHANICAL SEAL: 5/8" TYPE 21 VITON[®], CARBON, CERAMIC
- MULTIPLE SEAL OPTIONS AVAILABLE
- FRAME MOUNT, BASE PLATE, AND AIR MOTOR OPTION AVAILABLE
- RECIRCULATION FLUSH OPTION AVAILABLE
- VERTICAL OPTION AVAILABLE

TYPE OH

FLOWS TO 68 GPM / HEADS TO 160 FEET



PUMP ENERGY INDEX
.795 TO .855

FEATURES

- NEMA 56C MOTOR FRAME
- STANDARD MECHANICAL SEAL: 1" TYPE 36 VITON[®], CARBON VS. CERAMIC
- MULTIPLE SEAL OPTIONS AVAILABLE
- COMPACT CLOSE COUPLED DESIGN
- FRAME MOUNT & BASE PLATE OPTION AVAILABLE

MATERIALS

- CPVC
- PVDF

MODELS

- OH75CP – .75" x 1" x 6.12"
- OH75PF – .75" x 1" x 6.03"

APPLICATIONS

- WATER PURIFICATION
- DESALINATION
- REVERSE OSMOSIS
- MARINE
- TEMPERATURE CONTROL
- SUMP PUMPING
- ELECTRONICS
- PHOTO PROCESSING
- ACID TRANSFER
- CHILLERS
- METAL ETCHING
- RECIRCULATING

PUMP IS NONMETALIC WHEN USING A STANDARD TYPE 36 SEAL

TYPE HP

FLOWS TO 68 GPM / HEADS TO 185 FEET



PUMP ENERGY INDEX
0.746 TO .892

FEATURES

- NEMA 56J MOTOR FRAME
- STANDARD MECHANICAL SEAL: 5/8" TYPE 21 VITON[®], CARBON VS. CERAMIC (STAINLESS)
- STANDARD MECHANICAL SEAL: 5/8" TYPE 6 BUNA, CARBON VS. CERAMIC (CAST IRON)
- MULTIPLE SEAL OPTIONS AVAILABLE
- COMPACT CLOSE COUPLED DESIGN
- IMPELLER MATERIALS (CPVC, STAINLESS STEEL AND BRONZE)
- MAGNETICALLY DRIVEN OPTION AVAILABLE

MATERIALS

- STAINLESS STEEL
- BRONZE
- CPVC

MODELS

- HP75 – .75" x .75" x 6"
- HP100 – 1" x 1" x 6"

APPLICATIONS

- CIRCULATING CHILLED WATER
- BOOSTER PUMPS
- SPRINKLER PUMPS
- DEIONIZED WATER
- CHILLER PUMPS
- AIR CONDITIONING
- LASER COOLERS

TYPE MS

FLOWS TO 18 GPM / HEADS TO 390 FEET



MATERIALS

- STAINLESS STEEL

MODELS

- MS50 – .5" x .75" x 4.12"
- MULTIPLE STAGES AVAILABLE

APPLICATIONS

- DEIONIZED WATER SYSTEM
- ULTRA-FILTRATION SYSTEM
- LASER SYSTEM COOLING
- REVERSE OSMOSIS SYSTEMS
- ACID HANDLING

MULTIPLE STAGES AVAILABLE

FEATURES

- NEMA 56C MOTOR FRAME
- STANDARD MECHANICAL SEAL: 5/8" TYPE 21 VITON[®], CARBON VS. CERAMIC
- MULTIPLE SEAL OPTIONS AVAILABLE
- OPTIONAL POWER FRAME AVAILABLE
- MAGNETICALLY DRIVEN OPTION AVAILABLE

TYPE RP

FLOWS TO 44 GPM / HEADS TO 110 FEET



PUMP ENERGY INDEX
.845

FEATURES

- NEMA 56C MOTOR FRAME
- STANDARD MECHANICAL SEAL: 1" TYPE 36 VITON[®], CARBON VS. CERAMIC
- MULTIPLE SEAL OPTIONS AVAILABLE
- FRAME MOUNT & BASE PLATE OPTION AVAILABLE
- COMPACT CLOSE COUPLED DESIGN
- NEMA 56J MOTOR FRAME AVAILABLE

MATERIALS

- NORYL

MODELS

- RP75 – .75" x .75" x 5.12"

APPLICATIONS

- WATER PURIFICATION
- DESALINATION
- REVERSE OSMOSIS
- MARINE
- TEMPERATURE CONTROL
- SUMP PUMPING
- ELECTRONICS
- PHOTO PROCESSING
- ACID TRANSFER
- CHILLERS
- METAL ETCHING
- RECIRCULATING

PUMP IS NONMETALIC WHEN USING A STANDARD TYPE 36 SEAL



ANATOMY OF A PUMP

SPECIALLY DESIGNED BRACKETS ALLOW FOR MOTOR FRAMES THAT ARE AS SMALL AS 42C AND AS LARGE AS 356JM. IEC OPTIONS ARE ALSO AVAILABLE!

ENGINEERED, DESIGNED AND TESTED TO DELIVER OPTIMIZED PERFORMANCE AND TROUBLE FREE OPERATION OVER A WIDE VARIETY OF DIFFERENT APPLICATIONS!

SEAL OPTIONS INCLUDING DOUBLE SEALS, SPECIALIZED ELASTOMERS, AND ADVANCED SEAT AND SEAL MATERIALS ARE AVAILABLE ACROSS MOST PUMPS.

MULTIPLE VOLUTE AND IMPELLER OPTIONS ARE AVAILABLE. FROM MATERIALS LIKE STAINLESS STEEL AND ENGINEERED PLASTICS, TO FLANGED AND THREADED SUCTION AND DISCHARGE PORTS, WE HAVE A PUMP TO FIT YOUR NEEDS.

FLUSH, QUENCH, AND RECIRCULATION OPTIONS ARE AVAILABLE ON MOST PUMPS. ADDITIONAL CUSTOMIZATIONS ARE AVAILABLE UPON REQUEST. LET OUR ENGINEERS HELP YOU WITH YOUR PUMPING SOLUTIONS!

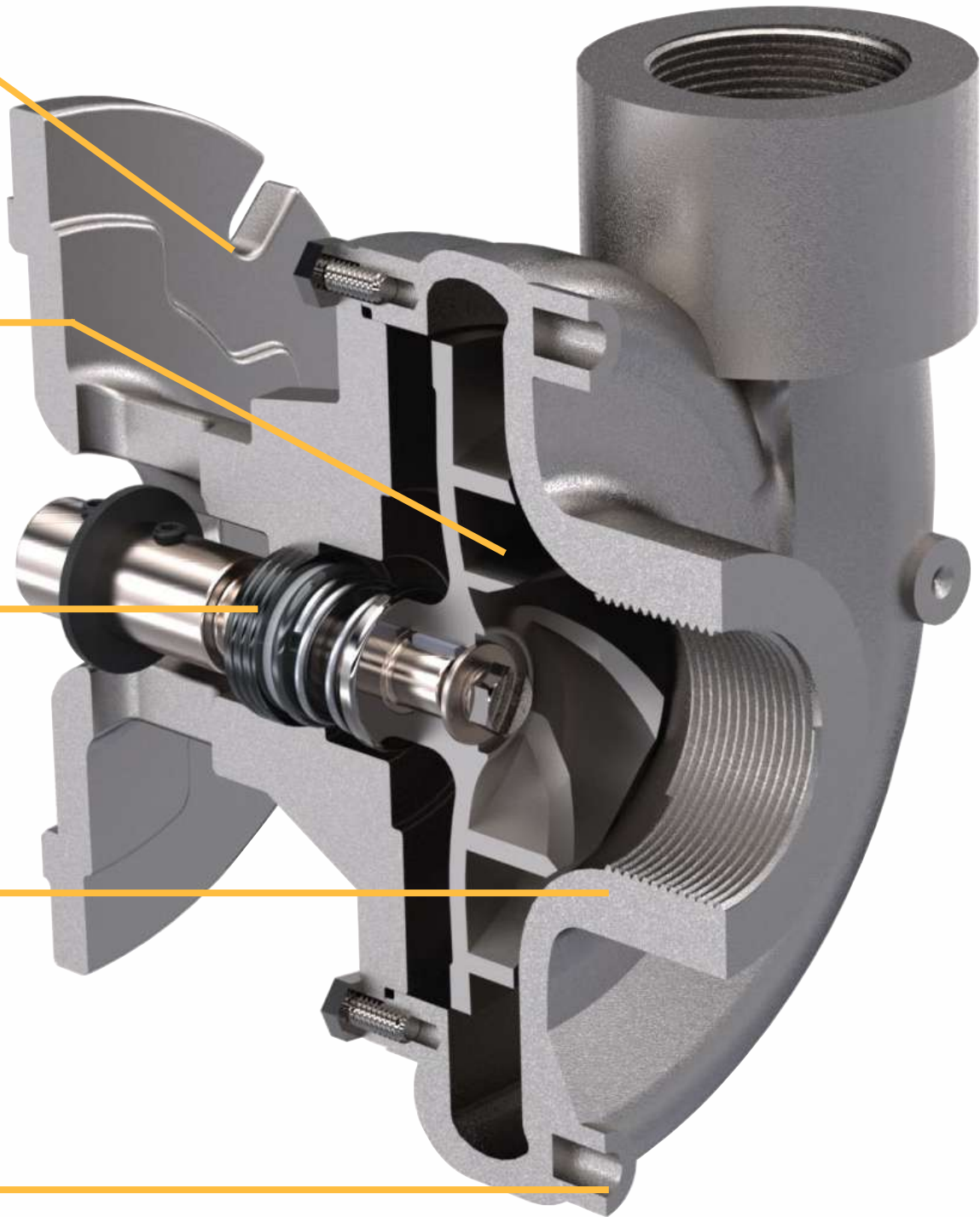

TYPE RC

FLOWS TO 420 GPM / HEADS TO 180 FEET



PUMP ENERGY INDEX
.970

FEATURES

- NEMA 56C MOTOR FRAME
- STANDARD MECHANICAL SEAL: 5/8" TYPE 6A BUNA, CARBON VS. CERAMIC (CAST IRON/BRONZE)
- STANDARD MECHANICAL SEAL: 5/8" TYPE 21 VITON, CARBON VS. CERAMIC (STAINLESS)
- MULTIPLE SEAL OPTIONS AVAILABLE
- FRAME MOUNT & BASE PLATE OPTION AVAILABLE
- VERTICAL OPTION AVAILABLE

MATERIALS

- STAINLESS STEEL
- BRONZE
- CAST IRON

MODELS

- RC200 – 2" x 2" x 4.06"
- RC300 – 3" x 3" x 4.62"

APPLICATIONS

- COOLANT PUMPS
- CHEMICAL TRANSFER
- COOLING TOWERS
- CIRCULATING
- WASHERS
- AQUACULTURE
- MACHINE TOOL COOLANTS

TYPE CD

FLOWS TO 170 GPM / HEADS TO 95 FEET



PUMP ENERGY INDEX
.930 TO .950

MATERIALS

- STAINLESS STEEL
- BRONZE
- CAST IRON
- HASTELLOY C

MODELS

- CD100 – 1" x 1.25" x 4.94"
- CD150 – 1.5" x 2" x 4.94"

APPLICATIONS

- TEMPERATURE CONTROL
- CHEMICAL PROCESS
- WASTEWATER TREATMENT
- AGRICULTURE – ACID FERTILIZERS OTHER AGRICULTURAL CHEMICALS

FEATURES

- NEMA 56C MOTOR FRAME
- STANDARD MECHANICAL SEAL: 5/8" TYPE 6A BUNA, CARBON VS. CERAMIC (CAST IRON, BRONZE)
- STANDARD MECHANICAL SEAL: 5/8" TYPE 21 VITON, CARBON VS. CERAMIC (STAINLESS STEEL)
- STANDARD MECHANICAL SEAL: 5/8" TYPE 9 TEFLON, CARBON VS. CERAMIC (HASTELLOY C)
- MULTIPLE SEAL OPTIONS AVAILABLE
- VERTICAL AND MAGNETICALLY DRIVEN OPTIONS AVAILABLE

TYPE SP

FLOWS TO 150 GPM / HEADS TO 97 FEET



MATERIALS

- CAST IRON
- STAINLESS STEEL

MODELS

- SP150 – 1.5" x 1.5" x 4.75/.50"

APPLICATIONS

- CHEMICAL TRANSFER
- PUMPING SOLVENTS
- AGRICULTURAL
- DEWATERING
- FILTERS
- GROUND WATER REMEDIATION
- CHEMICAL SUMP PUMPS
- WASTEWATER TREATMENTS

SELF-PRIMING PUMP

FEATURES

- NEMA 56C MOTOR FRAME - STANDARD
- STANDARD MECHANICAL SEAL: 3/4" TYPE 21 VITON[®], CARBON VS. CERAMIC (STAINLESS STEEL)
- STANDARD MECHANICAL SEAL: 3/4" TYPE 21 BUNA, CARBON VS. CERAMIC (CAST IRON)
- MULTIPLE SEAL OPTIONS AVAILABLE
- SEAL FLUSH AND OTHER OPTIONS AVAILABLE
- OPTIONAL FRAME MOUNTED AND AIR MOTOR
- SUCTION LIFT UP TO 20 FEET

TYPE CL

FLOWS TO 350 GPM / HEADS TO 155 FEET



MATERIALS

- STAINLESS STEEL

MODELS

- CL150 – 1.5" x 2" x 5.76"

APPLICATIONS

- ACIDS, ALKALIS, GLYCOLS, SOLVENTS, CAUSTICS
- REVERSE OSMOSIS
- SCRUBBERS
- FILTERS
- WASHERS
- DEIONIZED WATER

PUMP EFFICIENCY INDEX
.917

FEATURES

- NEMA 56C MOTOR FRAME
- STANDARD MECHANICAL SEAL: 1 1/2" TYPE 21 VITON[®], CARBON VS. CERAMIC
- MULTIPLE SEAL OPTIONS AVAILABLE
- FRAME MOUNT & BASE PLATE OPTION AVAILABLE
- SEAL FLUSH OPTIONAL
- VERTICAL AND MAGNETICALLY DRIVEN OPTIONS AVAILABLE

TYPE XT

FLOWS TO 400 GPM / HEADS TO 150 FEET



PUMP ENERGY INDEX
.933 TO .995

FEATURES

- NEMA 143 – 215JM MOTOR FRAME
- STANDARD MECHANICAL SEAL: 1 1/2" TYPE 21 BUNA (CAST IRON/BRONZE) AND TYPE 21 VITON® (STAINLESS STEEL), CARBON VS. CERAMIC
- MULTIPLE SEAL OPTIONS AVAILABLE
- FRAME MOUNT & BASE PLATE OPTION AVAILABLE
- VERTICAL AND MAGNETICALLY DRIVEN OPTIONS AVAILABLE

MATERIALS

- STAINLESS STEEL
- BRONZE
- CAST IRON

MODELS

- XT100 – 1" x 1.5" x 5.98"
- XT150 – 1.5" x 2" x 5.98"
- XT200 – 2" x 3" x 5.98"

APPLICATIONS

- CHEMICAL PROCESS
- DEIONIZED WATER
- COOLING TOWER
- CHILLERS
- PLATING EQUIPMENT
- HOT SOLVENTS, CAUSTICS
- WATER AND WASTEWATER TREATMENT

TYPE XL

FLOWS TO 400 GPM / HEADS TO 150 FEET

MATERIALS

- STAINLESS STEEL

MODELS

- XL100 – 1" x 1.5" x 5.98"
- XL150 – 1.5" x 3" x 5.98"
- XL200 – 2" x 3" x 5.98"

APPLICATIONS

- CHEMICAL PROCESS
- DEIONIZED WATER
- COOLING TOWER
- CHILLERS
- PLATING EQUIPMENT
- HOT SOLVENTS, CAUSTICS
- WATER AND WASTEWATER TREATMENT



PUMP ENERGY INDEX
.883 TO .948

FEATURES

- NEMA 143 – 215JM MOTOR FRAME
- STANDARD MECHANICAL SEAL: 1 1/2" TYPE 21 VITON® CARBON VS. CERAMIC
- MULTIPLE SEAL OPTIONS AVAILABLE
- FRAME MOUNT & BASE PLATE OPTION AVAILABLE
- VERTICAL AND MAGNETICALLY DRIVEN OPTIONS AVAILABLE

TYPE JB

FLOWS TO 580 GPM / HEADS TO 290 FEET



PUMP ENERGY INDEX
.823 TO .980

FEATURES

- NEMA 143 – 324JM MOTOR FRAME
- STANDARD MECHANICAL SEAL: 1 1/2" TYPE 21 VITON[®], CARBON VS. CERAMIC
- MULTIPLE SEAL OPTIONS AVAILABLE
- FRAME MOUNT & BASE PLATE OPTION AVAILABLE

MATERIALS

- STAINLESS STEEL

MODELS

- JB100 – 1" x 1.5" x 8"
- JB150 – 1.5" x 2" x 8"
- JB200 – 2" x 3" x 8"

APPLICATIONS

- WASTE WATER TREATMENT
- MUNICIPAL WATER TREATMENT
- ACID MINE DRAINAGE
- FRAC WATER TREATMENT
- OILFIELD BRINE
- CHEMICAL PROCESS
- TRANSFER
- IRRIGATION / DRAINAGE

TYPE XJ

FLOWS TO 1100 GPM / HEADS TO 320 FEET



PUMP ENERGY INDEX
823 TO .990

FEATURES

- NEMA 143 – 365JM MOTOR FRAME
- STANDARD MECHANICAL SEAL: 1 1/2" TYPE 21 VITON[®], CARBON VS. CERAMIC
- MULTIPLE SEAL OPTIONS AVAILABLE
- FRAME MOUNT & BASE PLATE OPTION AVAILABLE

MATERIALS

- STAINLESS STEEL

MODELS

- XJ100 – 1" x 1.5" x 8"
- XJ150 – 1.5" x 3" x 8"
- XJ200 – 2" x 3" x 8"
- XJ400 – 4" x 4" x 8.5"

APPLICATIONS

- WASTE WATER TREATMENT
- MUNICIPAL WATER TREATMENT
- ACID MINE DRAINAGE
- FRAC WATER TREATMENT
- OILFIELD BRINE
- CHEMICAL PROCESS
- TRANSFER
- IRRIGATION / DRAINAGE

ABOUT PRICE PUMP®

1932

FOUNDED BY E.L. PRICE IN EMERYVILLE, CALIFORNIA.

1962

PRICE PUMP® IS ACQUIRED BY LEON J. PAUL AND THE NAME IS RETAINED DUE TO THE REPUTATION FOR QUALITY AND SERVICE.

1980

THE AGRICULTURE MARKET IS REPLACED BY CHEMICAL, LASER, AND SEMICONDUCTOR MARKETS.

1989

PRICE PUMP® RELOCATES TO THEIR 32,000 SQUARE FOOT SONOMA CALIFORNIA FACILITY.

1992

BOB PIAZZA JOINS AS PRESIDENT AND BRINGS A LIFETIME OF PUMP EXPERIENCE.



1994

PRICE PUMP® CONTINUES TO INNOVATE AND LAUNCHES A LINE OF MAGNETICALLY DRIVEN SEALLESS PUMPS.

1999

AIR OPERATED DIAPHRAGM (AOD®) PUMPS ARE ACQUIRED FROM ITT-MARLOW.



2007

PRICE PUMP® PARTNERS WITH MITSUBISHI ELECTRIC AUTOMATION AND INTRODUCES VARIABLE FREQUENCY DRIVES (VFD).

2010

THE XJ400 IS INTRODUCED PRODUCING FLOWS OVER 1000 GALLONS PER MINUTE.

2012

PRICE PUMP® BECOMES AN ISO 9001 CERTIFIED COMPANY.



2012-2017

THE PURCHASE OF A NEW 3D PRINTER AND ADDITIONAL INVESTMENT IN ENGINEERING DESIGN AND DEVELOPMENT LEAD TO RAPID PROTOTYPING. THIS LEADS TO SEVERAL NEW PUMP RELEASES.

2019

NEW CORPORATE HEADQUARTERS OPENED AT 2203 SMEED PARKWAY IN CALDWELL IDAHO. PRICE PUMP® MOVES ALL PRODUCTION TO THIS NEW FACILITY.



2020

PRICE PUMP® FINISHES COMPLIANCE TESTING IN THEIR NEWLY CONSTRUCTED STATE OF THE ART TEST FACILITY; VERIFICATION OF COMPLIANCE WITH DEPARTMENT OF ENERGY PUMP ENERGY INDEX STANDARDS IS COMPLETED.

CHECK OUT OUR OTHER PRODUCT OFFERINGS



**SEALLESS CENTRIFUGAL
PUMPS**



**VERTICAL CENTRIFUGAL
PUMPS**



**AIR OPERATED DIAPHRAGM
(AOD®) PUMPS**

FOR MORE INFORMATION PLEASE VISIT WWW.PRICEPUMP.COM

NOTES

A series of horizontal dotted lines for taking notes.

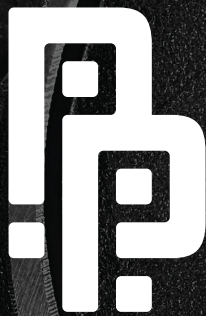

PRICE PUMP®

FOR ALL OF OUR CURRENT OFFERINGS AND LOCAL REPRESENTATIVES
PLEASE VISIT WWW.PRICEPUMP.COM

2203 SMEED PARKWAY
CALDWELL, ID 83605
1-800-345-PUMP (7867)

